

Automotive fan system simulation with Code_Saturne



User meeting – Chatou, France



April 2nd, 2015

Outline

- Introduction
 - Virtual development / optimization processes
 - ANR project Pepito
 - Motivation / objectives
- Demonstrator
 - Simplified case description
 - Methodology and workflow
 - Study on CPU time and comparison with commercial software
- Industrial case
 - Description of the test rig simulation / Simulation set/up
 - Results and comparisons with experimental data
- Conclusion and perspective



Introduction



User meeting – Chatou, France



April 2nd, 2015

Virtual development

- *Simulation is a strong asset in the design process:*

- *Faster development cycle*
- *Deep analyze of the physics*
- *Reduced costs...*

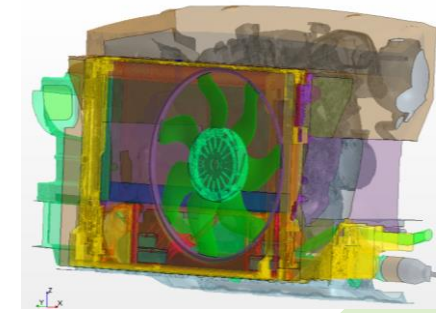
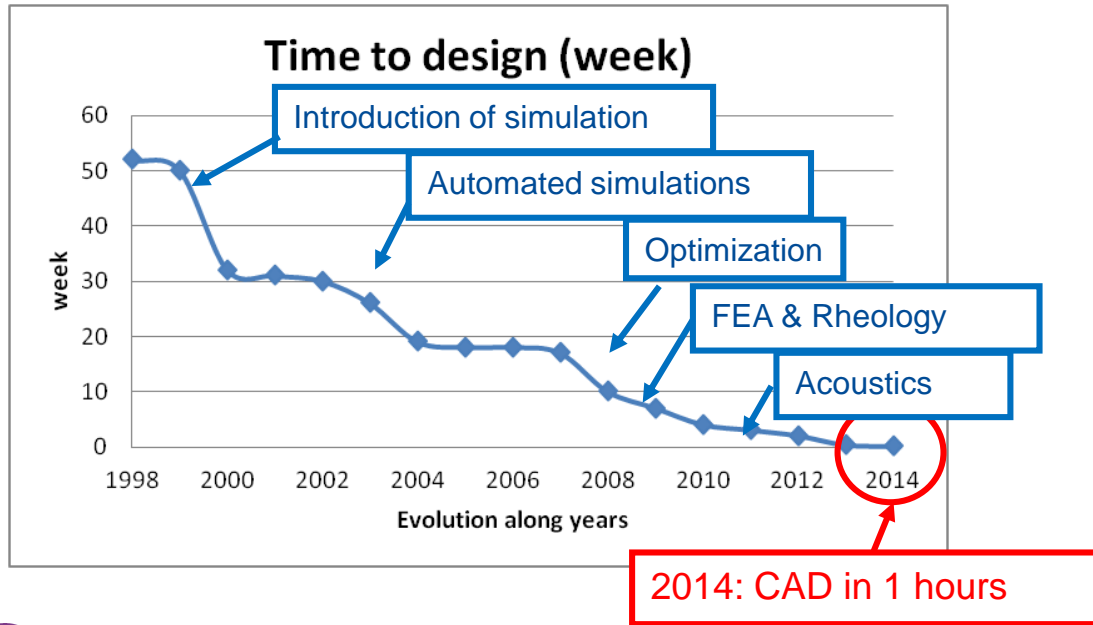

System integration and validation

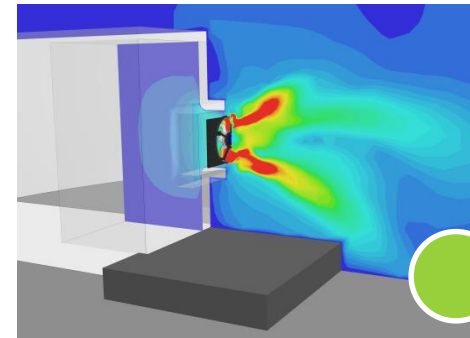

Performance prediction

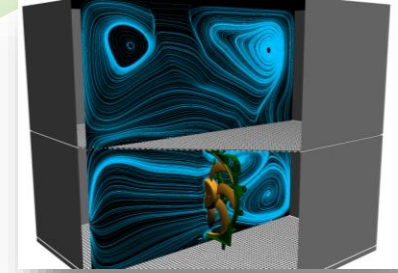

Design

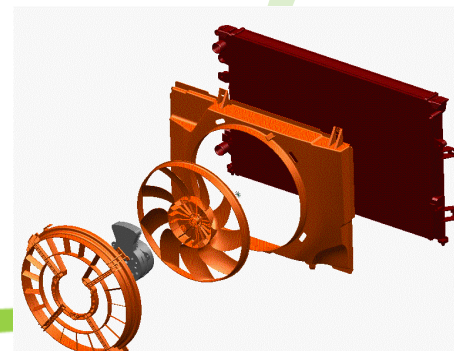
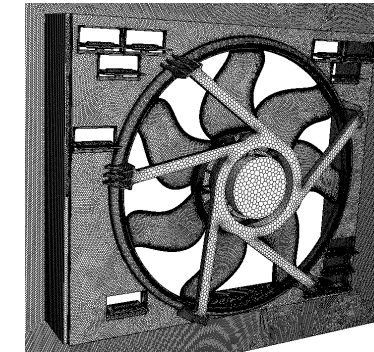

Optimization process

● Optimization (Isight)

- NOLH sampling for DoE (statistical distribution for all factors)
- Response surface model (RSM) with radial base functions
- Genetic algorithm NSGA2 for research of optima (ranking along generation)

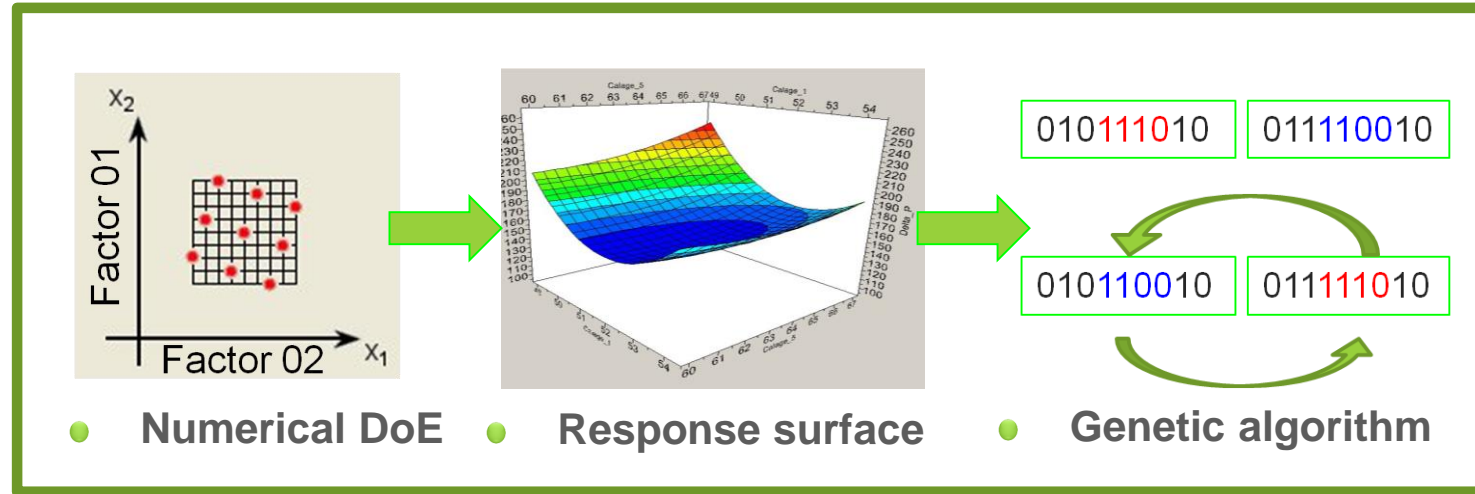

● Fan design

- 11 parameter DOE (10 geometrical, 1 physical parameter)
- Optimized designs are often unconventional, and take into account the real physics (3D effects, tip recirculation, hub,...)

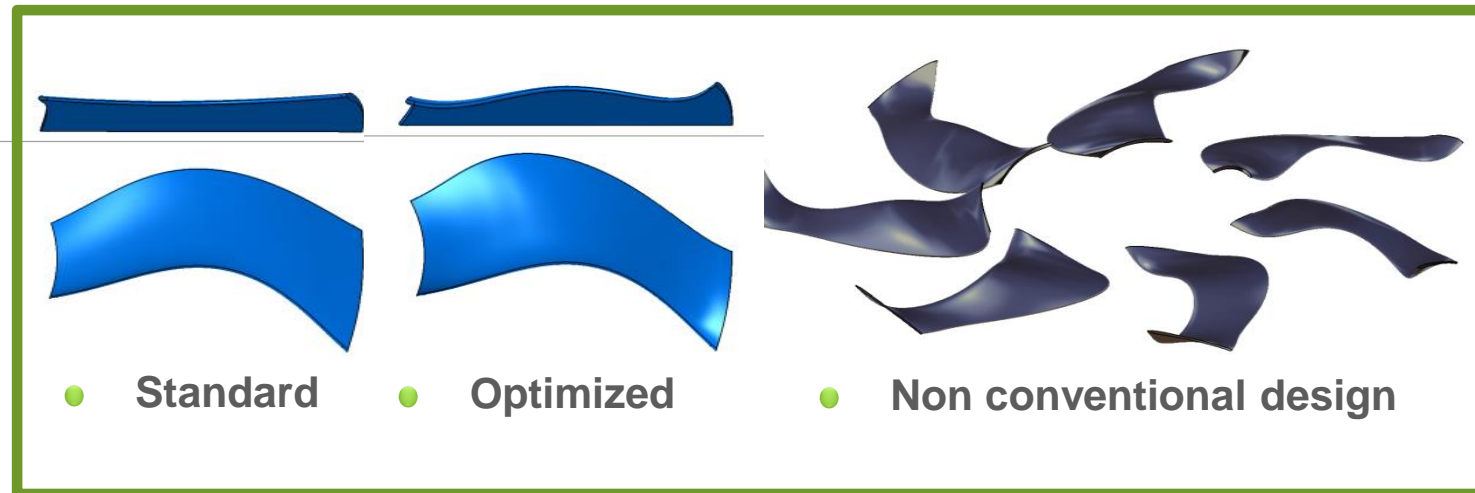

- **Plan d'Expérience Pour l'Industrie du Transport et l'Optimisation**
- Fan system case (turbomachine simulation)
- Optimization in large dimension
 - Domain extension up to 60 factors
 - Wide range of variation for each factor
- High Power Computing
 - Several thousands of simulation
 - Open-source code for parallel computing (unlimited number of case running together and each on hundreds of core)
 - Code_Saturne selected for accuracy and quality assurance

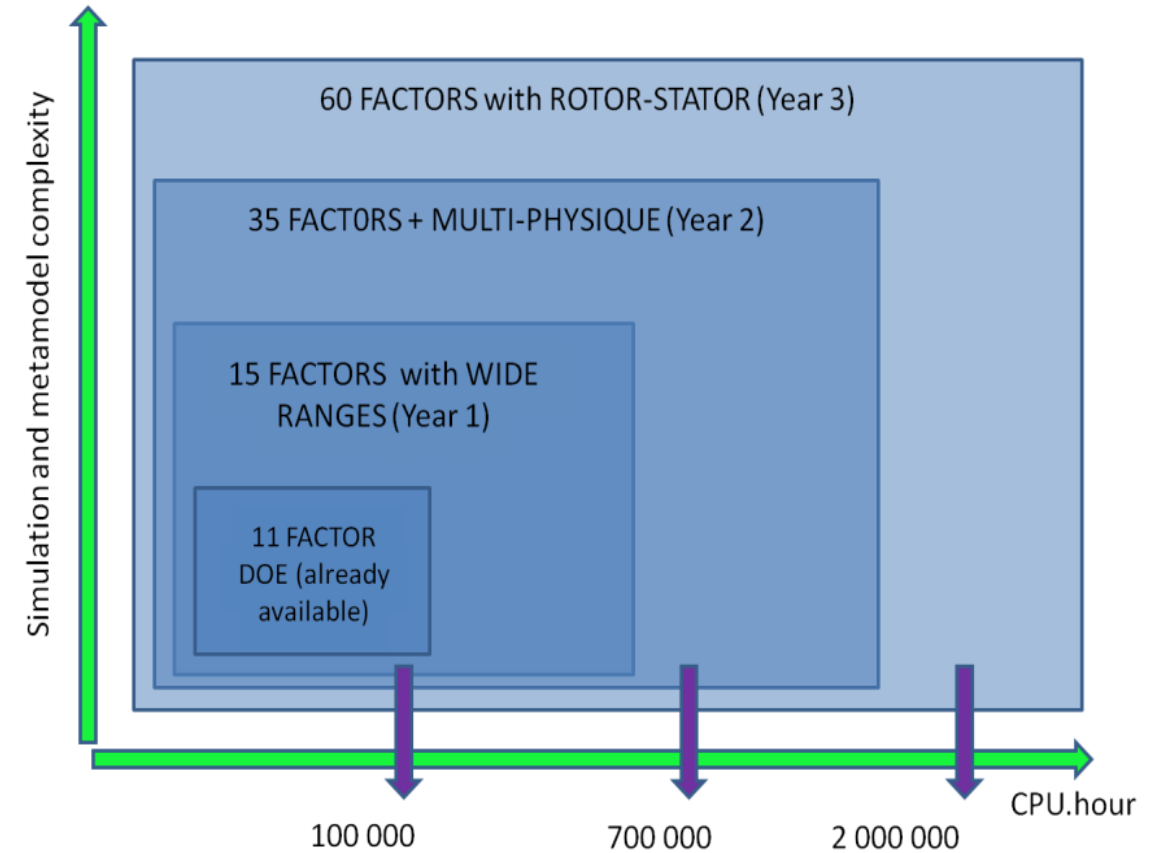

Motivation / objectives

- Handle usage of Code_Saturne
 - Test and implement simulation methodology for fan system
- Assess code performance
 - Size case and DoE according to CPU resources
 - Estimate accuracy of results used for surface response models

Demonstrator

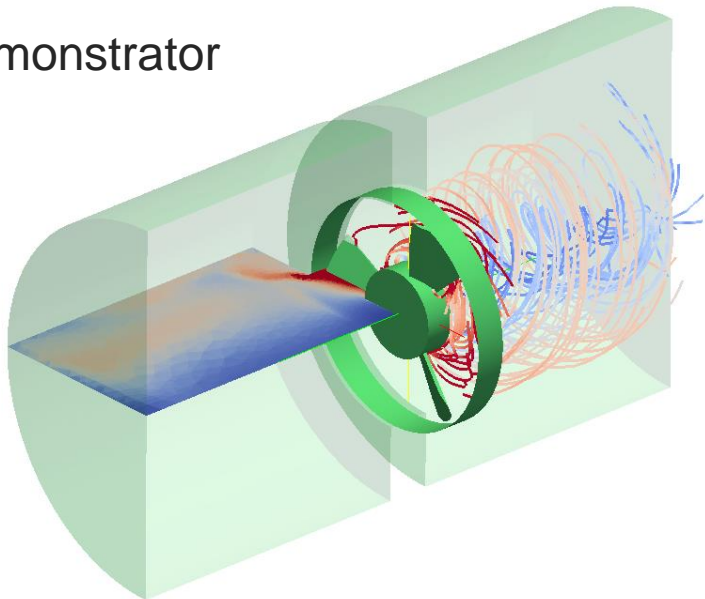

Full test-rig simulation





Demonstrator



User meeting – Chatou, France



April 2nd, 2015

Simplified case description

- Simple and realistic geometry
 - Small inlet and outlet domains
 - 3 blade fan with tip clearance
 - Axi-symmetrical case
- Relevant test case for turbomachinery
 - Plane and circular interfaces
 - Multiple Reference Frame for steady simulation
 - Sliding mesh for unsteady simulation
- Easy use for comparisons
 - Small simulation case, i.e. ~ 1,2 million tetrahedral cells

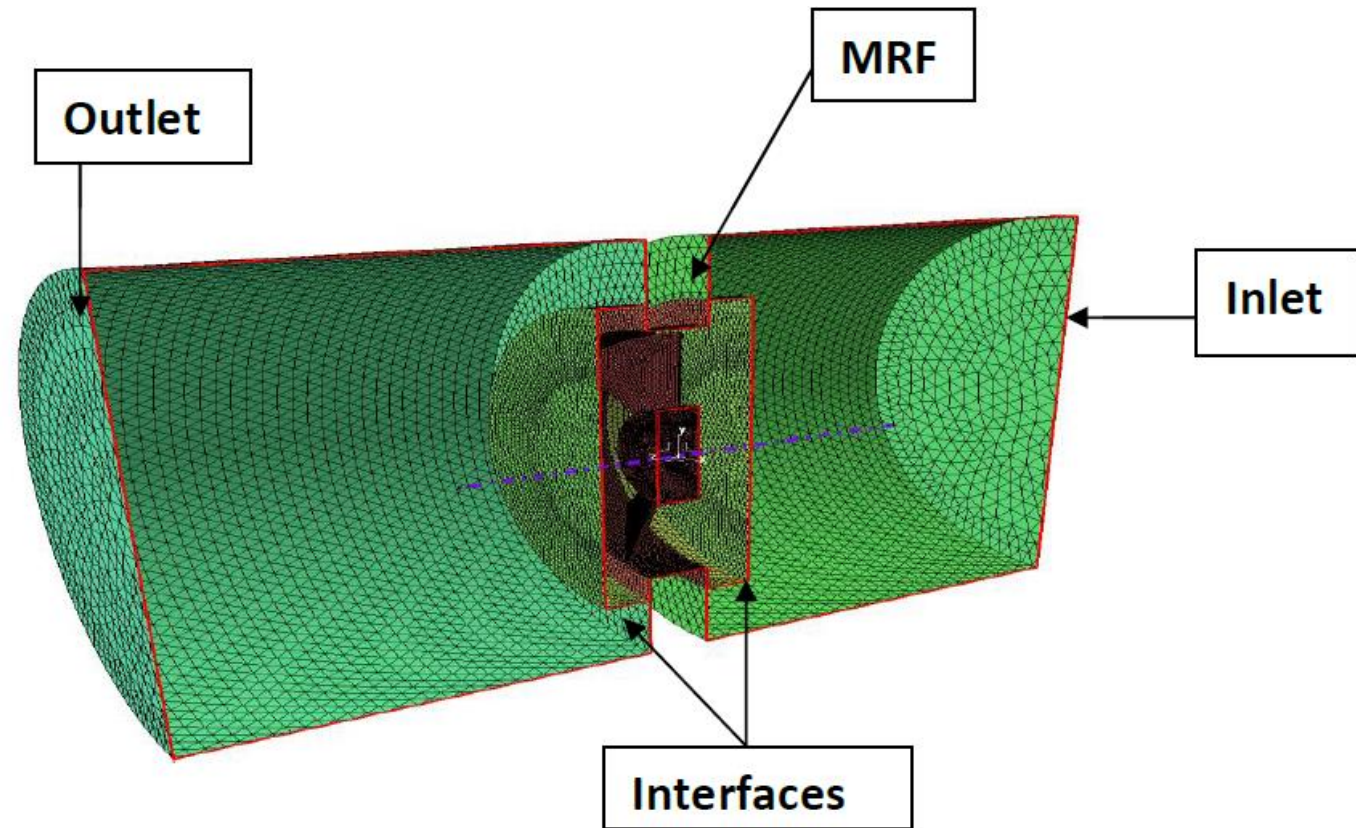

Simulation processes

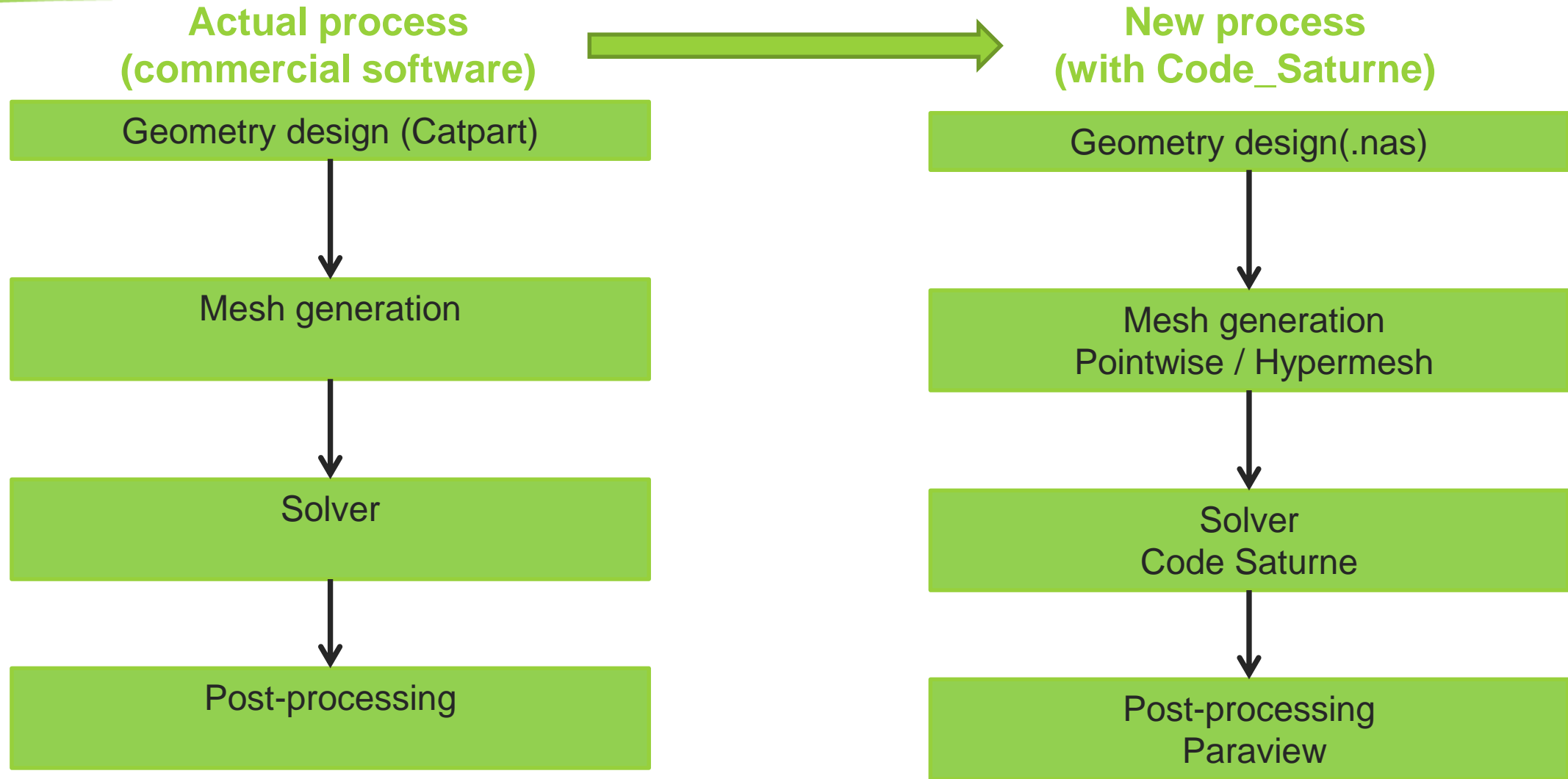

- Tested and developed during Pepito project
- To be further used in an industrial context

Results : global performances (steady)

Δp steady simulation

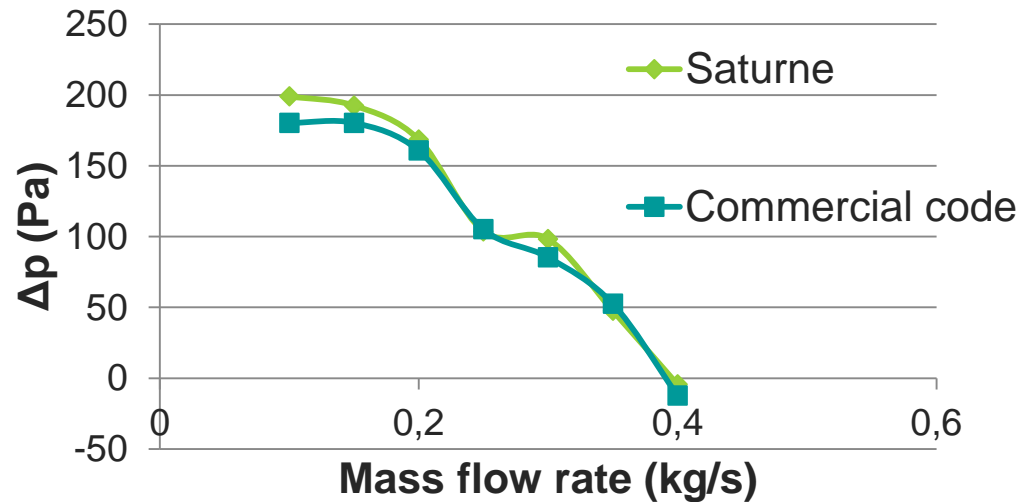

Torque steady simulation

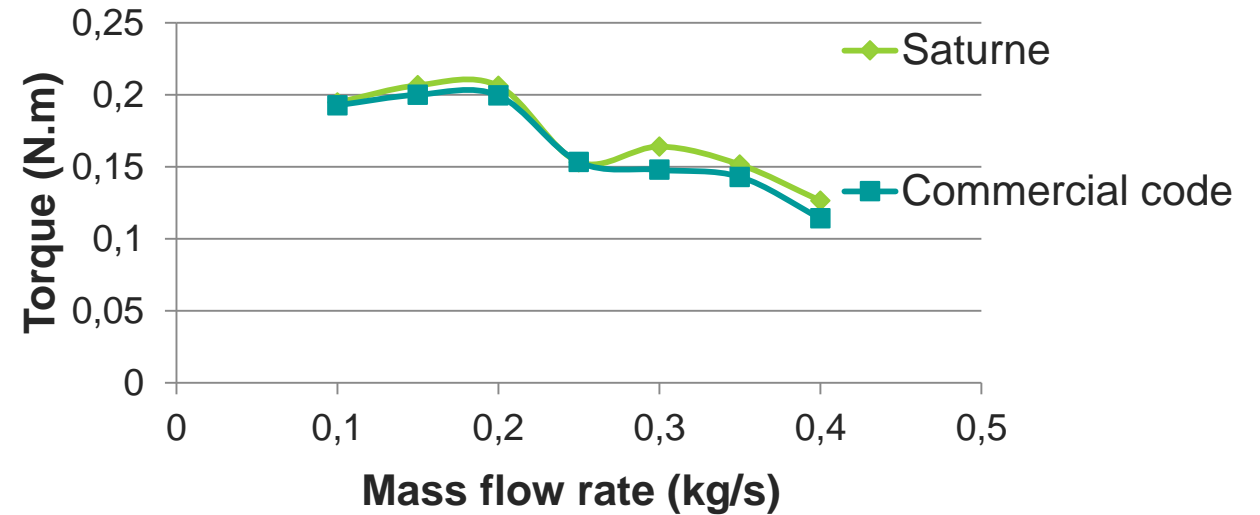

● Result comparisons

- Good agreement between codes on global performances
- To be completed with a deeper analysis of the flow, even if the interest for this fan is limited

Results : global performances (unsteady)

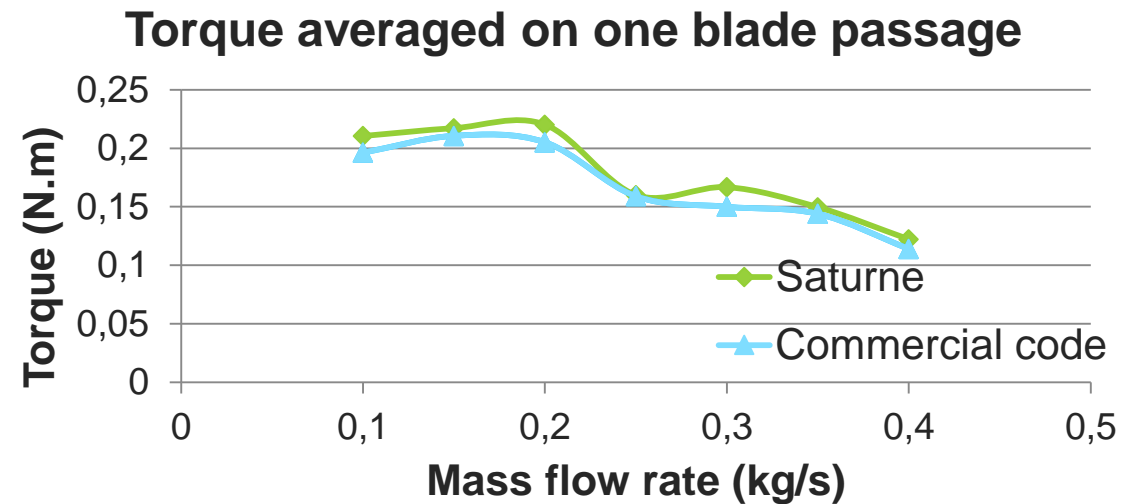
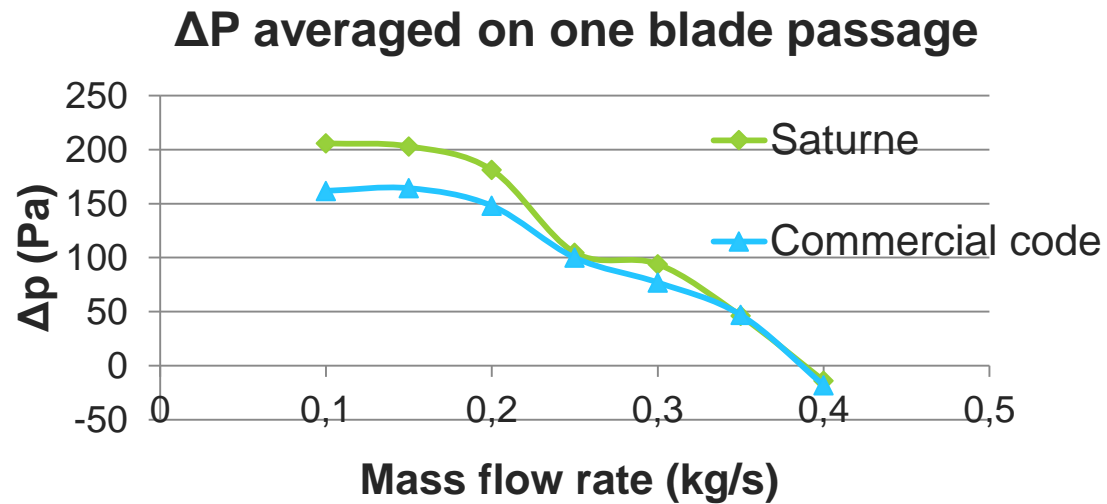

● Result comparisons

- Same performance with Code_Saturne between steady and unsteady simulations
- Lower pressure levels with unsteady simulation for the commercial code
- On-going investigation to explain the difference:
 - Separation effect on the profile not correctly predicted (squared thick leading edge)?

Influence of the solver precision on accuracy

Effect of solver precision

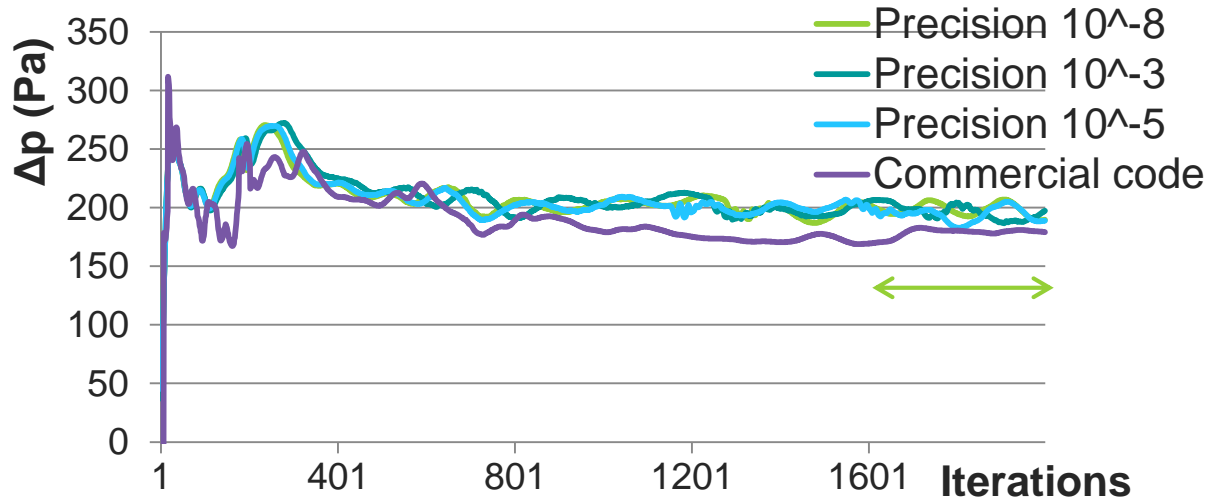

Effect of solver precision

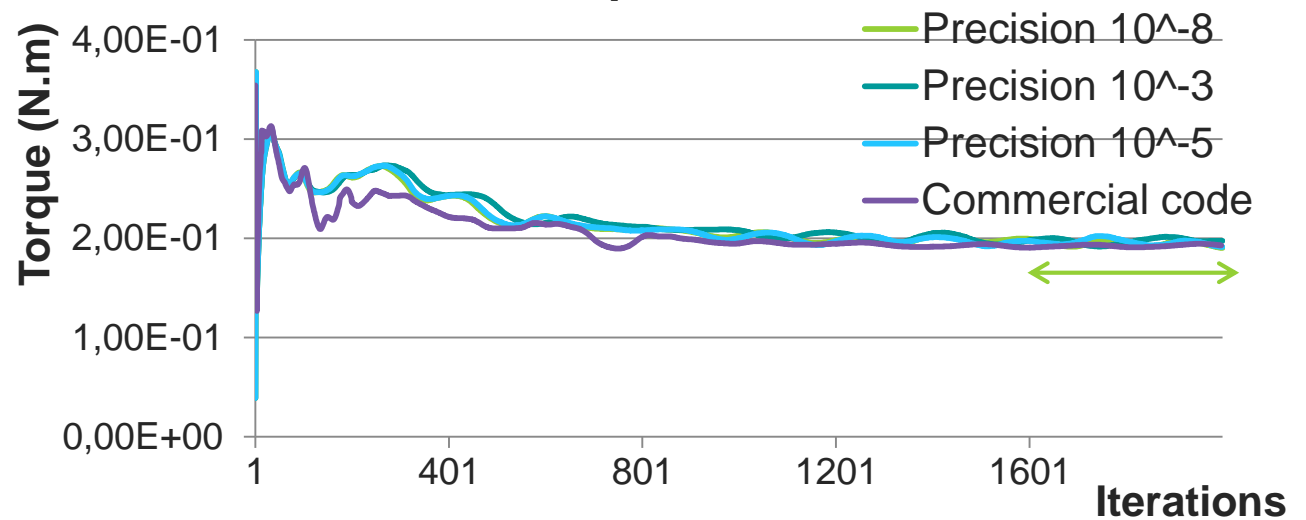

solver precision	Δp (Pa) ave. last 400 ite.	Torque (Nm) ave. last 400 ite.
10^{-8} (default Value)	199	0,194
10^{-5}	194	0,196
10^{-3}	197	0,197

- Identical convergence curves for both codes over 2000 iterations
- Discrepancy of about 5Pa (~2,5%)
- Small oscillations with lower precision

Influence of the solver precision on calculation time

Solver Precision	N_cycle (Pressure)	N_cycle (Velocity)	Iterations/Hour
10^{-8} (default Value)	~400	~30	719
10^{-5}	~95	~15	1290
10^{-3}	~20	~5	1714



- Reduced number of cycle per iteration with lower precision target
- Potential gain on simulation time (divided by 2) if ~2,5% discrepancy is acceptable
- Unknown risk on the robustness of the solution, 10^{-5} might be a good compromise

Results: comparison of CPU time

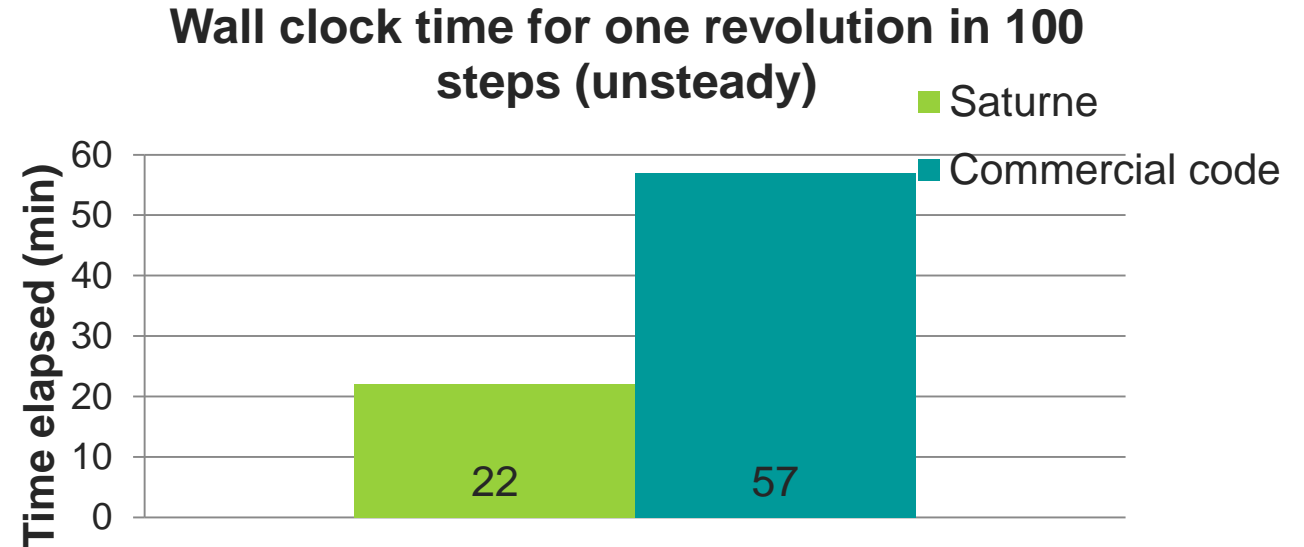
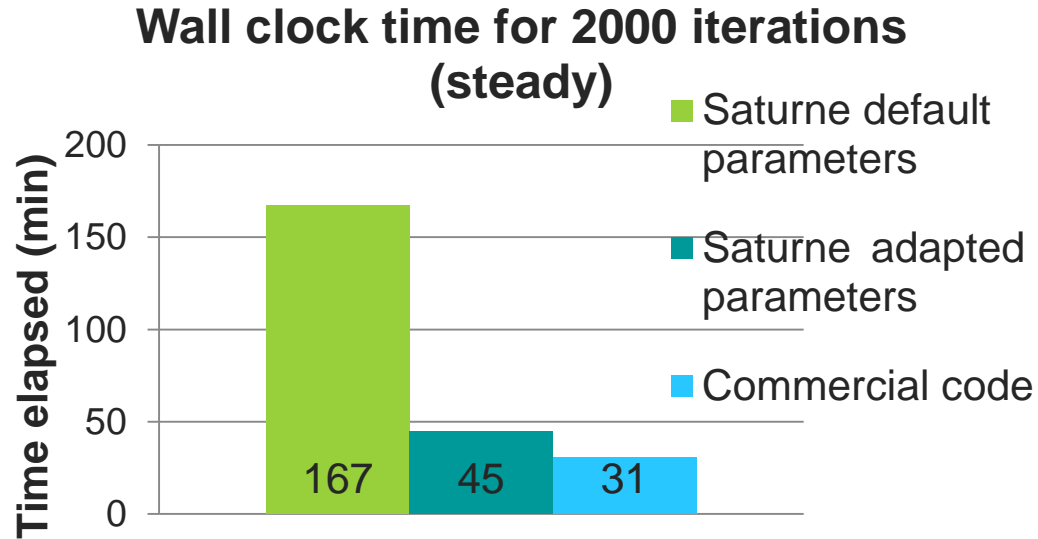

- Default parameter with Code_Saturne can not compete with commercial code in term of speed for steady simulation
- Adapted parameters are in favor of CPU time over robustness and accuracy. It is necessary to validate such a set up (some discrepancies observed).
- Code_Saturne is very competitive for unsteady simulation (even with default parameters)



Industrial case



User meeting – Chatou, France



April 2nd, 2015

Full test-rig simulation

- Detailed description of both fan and labs (masking effect of the torquemeter, ground and wall description, etc...)



Experiment

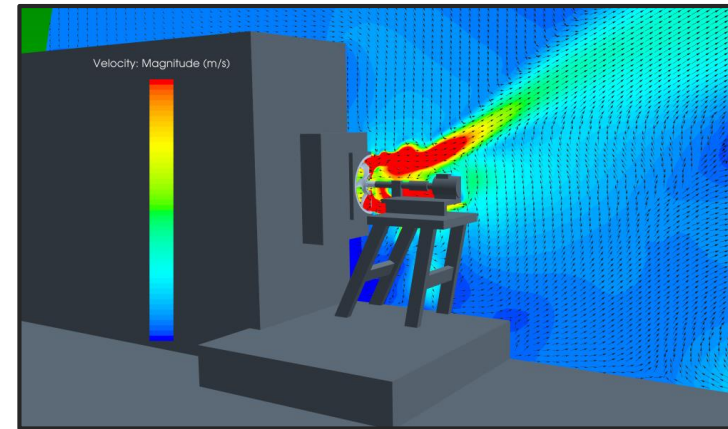

Simulation

- Geometry and domain of simulation

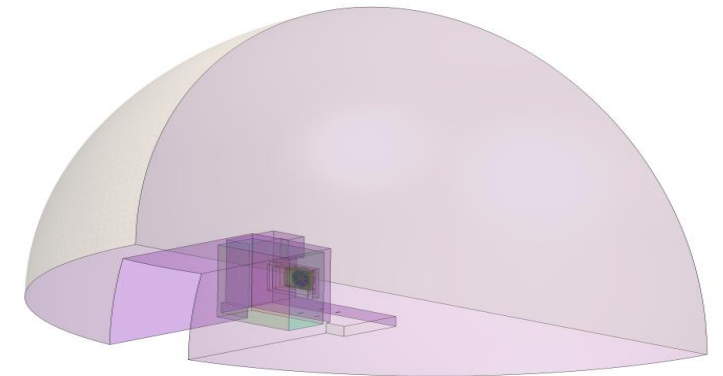
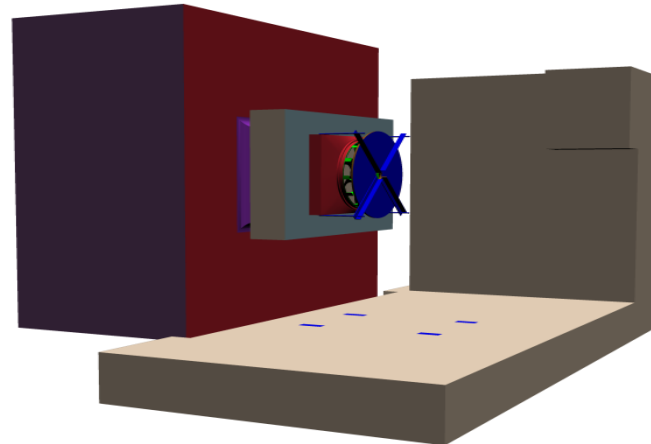
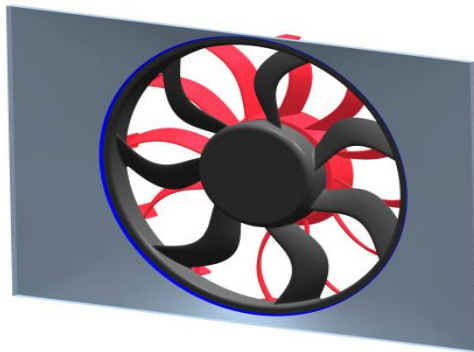

Mesh and simulation set-up

- Meshing process (Pointwise)
 - 2D meshes generated with expert model
 - Unstructured mesh (tetrahedral)
 - Refinement and smooth transition in critical area (tip clearance, leading and trailing edges, etc...)
 - Automation of the mesh process with scripts
- RANS simulation
 - RANS and URANS simulation
 - K- ω turbulence model, two-layer model for boundary conditions
 - Monitoring of global performances and residuals to check convergence

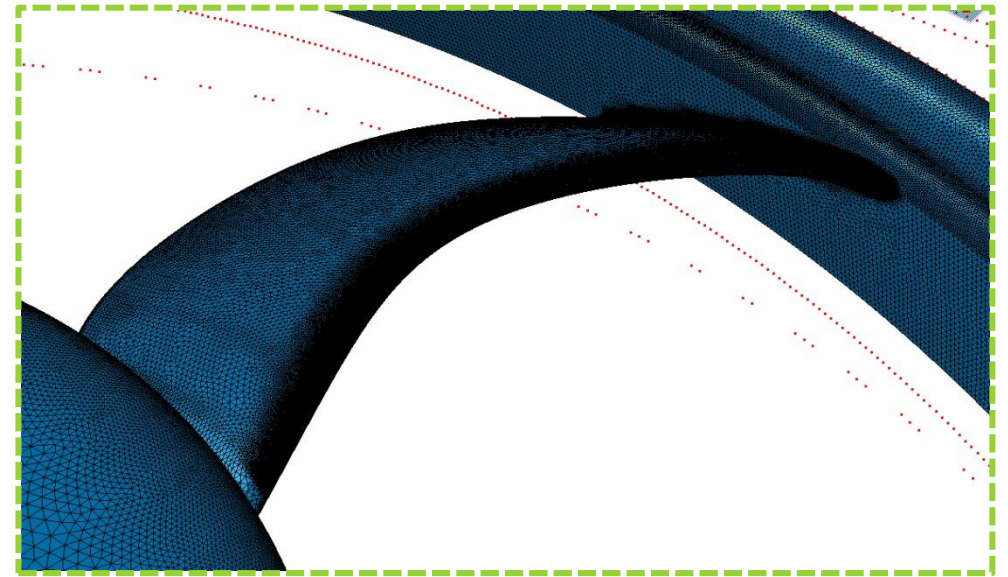

Fan surface mesh

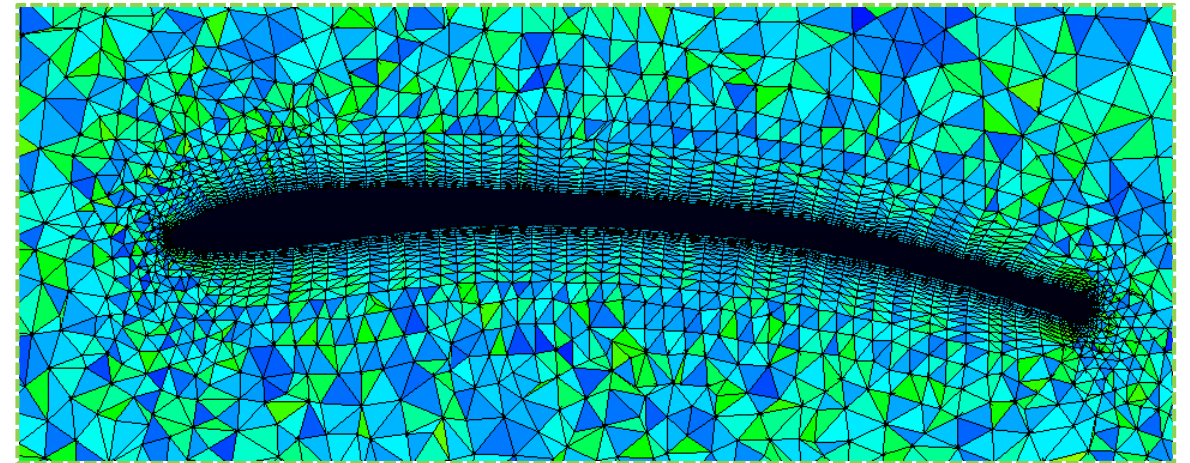

Tetrahedral mesh on a profil

Numerical / experimental result comparisons

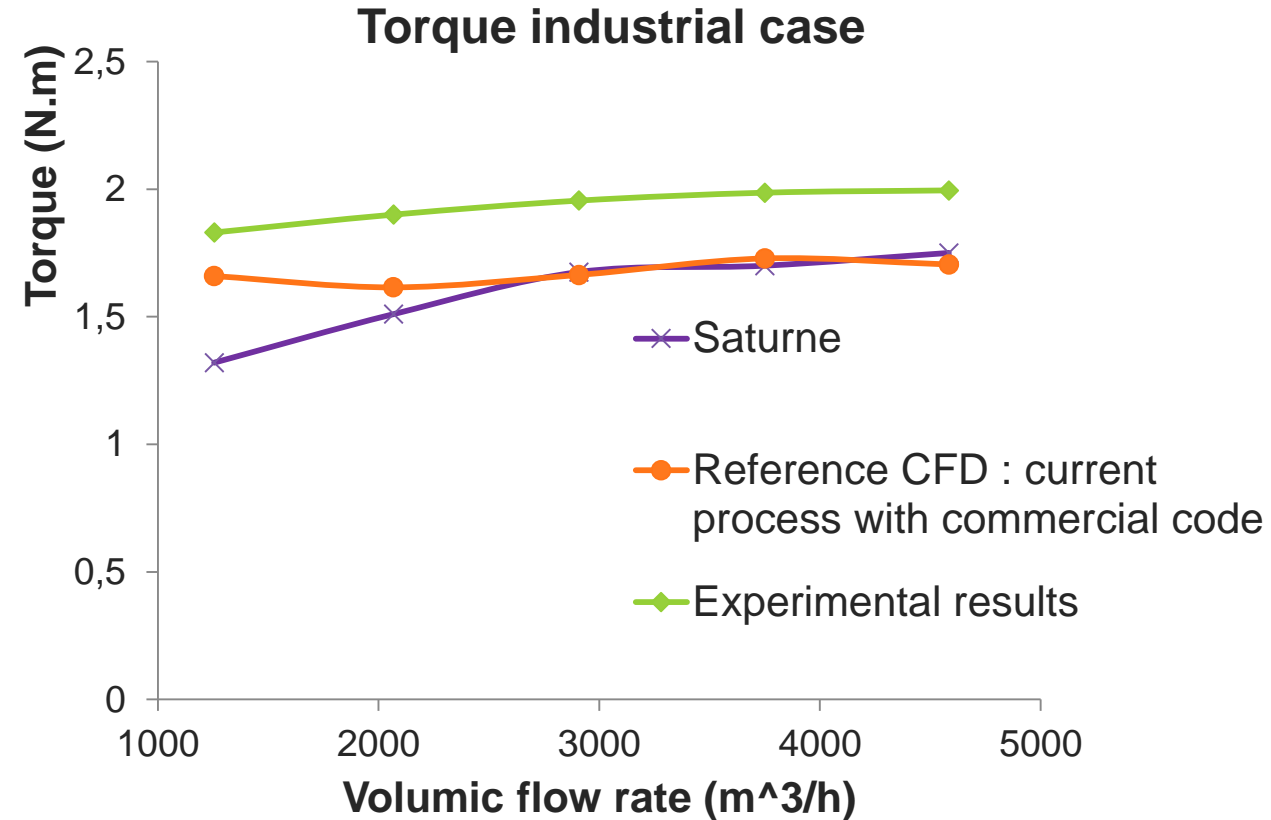
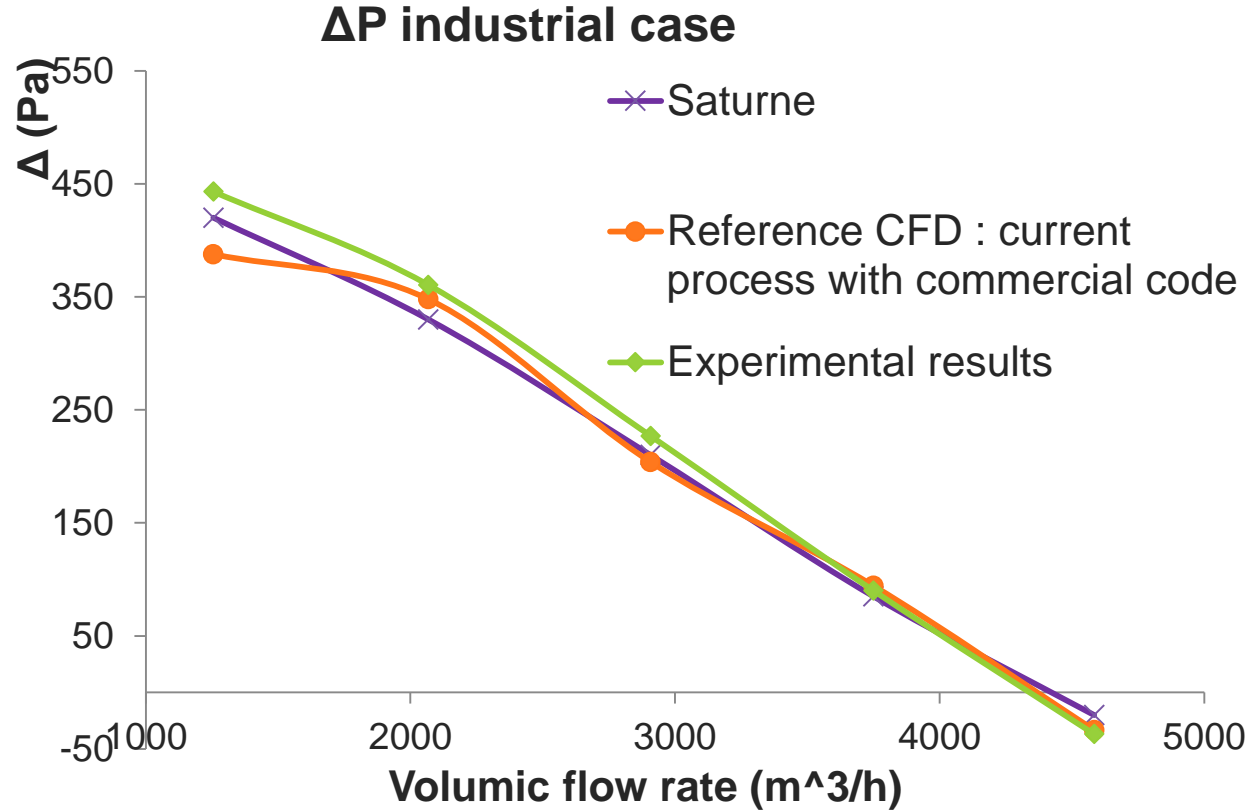

- Very good agreement between experiment, reference simulation and Saturne predictions for pressure rise.
- Slight offset between experiment and CFD for torque (on-going investigation on experimental set-up).



Conclusion and perspectives



User meeting – Chatou, France



April 2nd, 2015

Overall conclusion

- Code_Saturne tests at Valeo
 - Full simulation process for Code_Saturne successfully experimented
 - Accuracy validated for our industrial cases
 - “CPU” performance assessed for steady and unsteady simulation

- Applications for optimization
 - Workflow for full system simulation under development (cooling module with fan system)
 - Design of Experiment to be conducted with large number of parameter
 - Other applications identified, to be deployed in R&D department



Automotive technology, naturally