

Lightning Strike on aircraft: Simulation With the electric module of *Code_Saturne*®

Collaboration ONERA-EDF-CEAT-CORIA
Laurent Chemartin



I. Introduction: Lightning Strike to an Aircraft

Lightning strike to an aircraft

- Struck by lightning once a year
- Ignited most of the time (90 %) by the aircraft itself
- Occurs most of the time, during landing and taking off stage

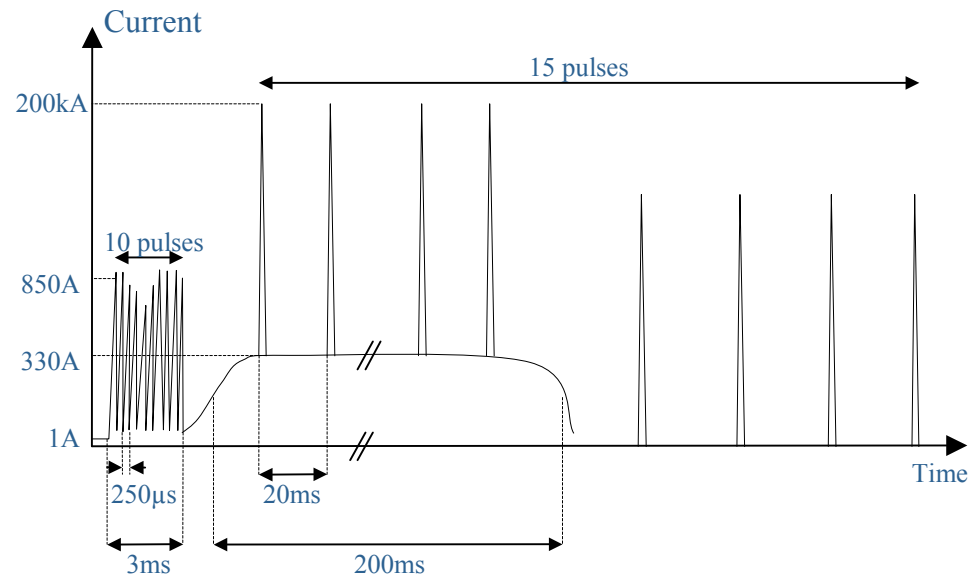
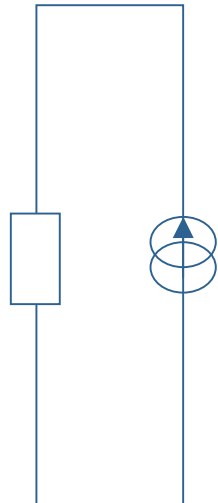
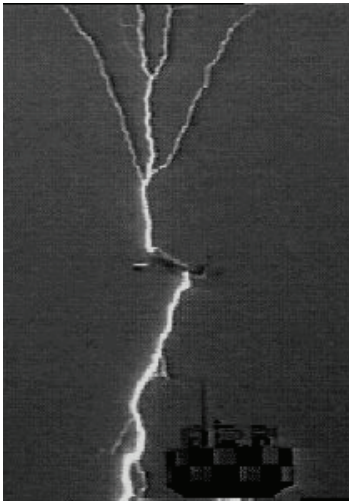

I. Introduction: Lightning Strike to an Aircraft

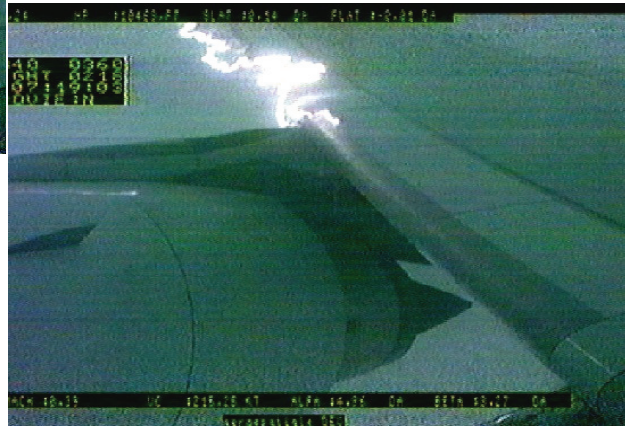
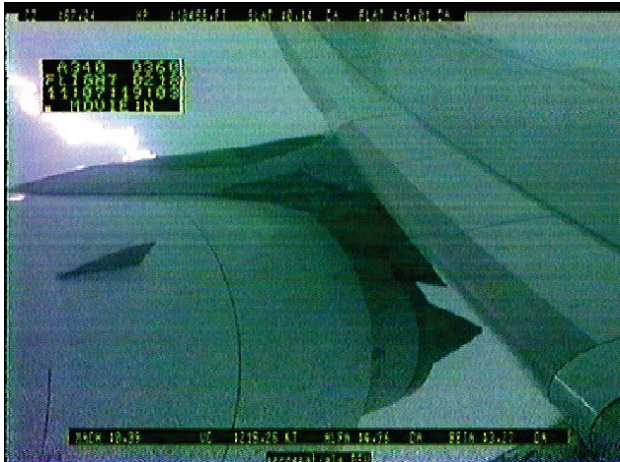

Images Airbus France

I. Introduction: Lightning Strike to an Aircraft

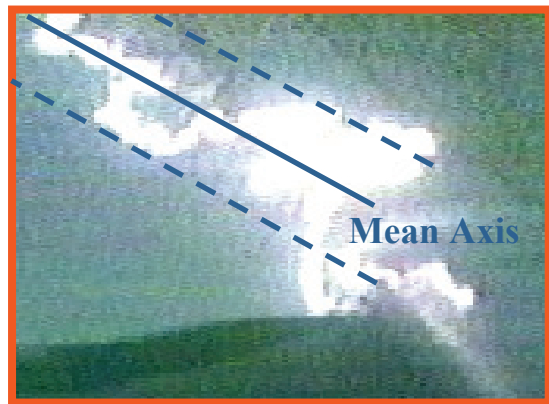
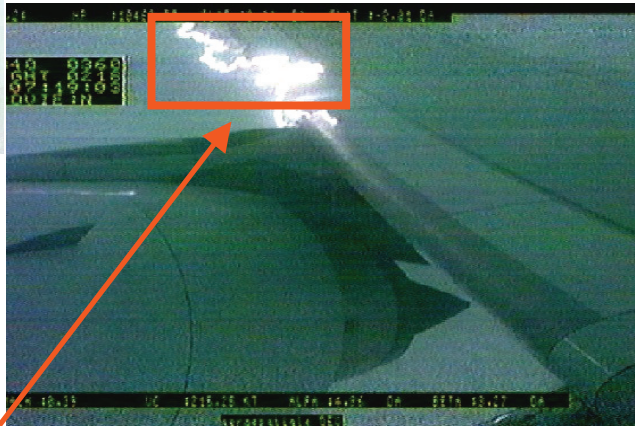
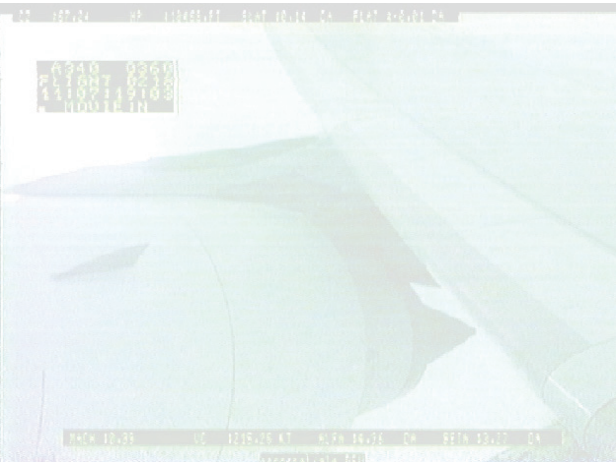

Lightning Channel Properties

Images Airbus France

I. Introduction: Lightning Strike to an Aircraft

Interaction with the material

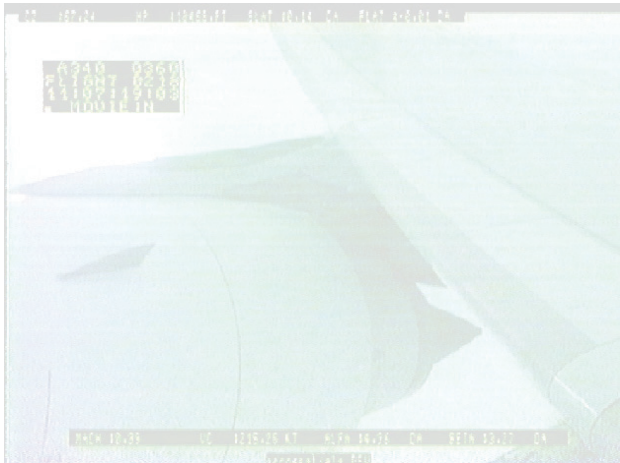

Images Airbus France

I. Introduction: Electric module of *Code_Saturne*®

Electric Arc modelling: Resistive Magneto Hydrodynamic

- Heating Source: Joule Heating: $J \cdot E$

(E and J calculated by an equation on the electric potential ϕ) $\nabla \cdot \sigma \nabla \phi = 0$

- Momentum Source Term: Laplace Force $J \times B$

(B calculated by an equation on the magnetic vector potential A) $\nabla \cdot \nabla A_i = \mu_0 J_i$

Main assumptions

- Local Thermal Equilibrium (LTE):
- Incompressible flow ($Ma < 0,1$)
- Simplified Ohm's Law (no Induction, no Hall effect)
- Static Electric and Magnetic field
- Radiative Transfert: Net emission Coefficient

II. Lightning Channel : problematic



Long arc column: no electrode influences

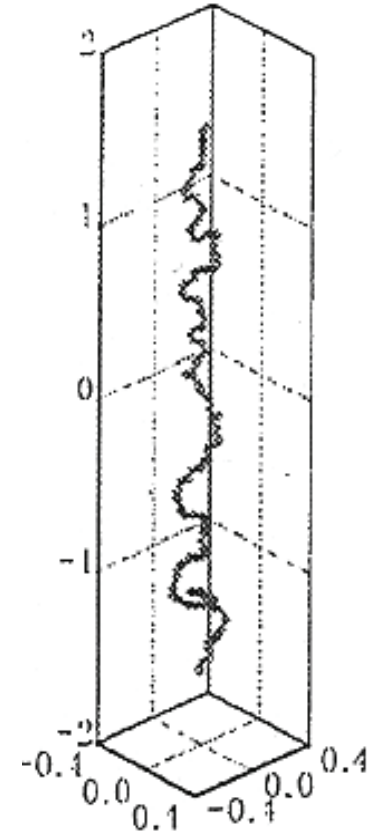
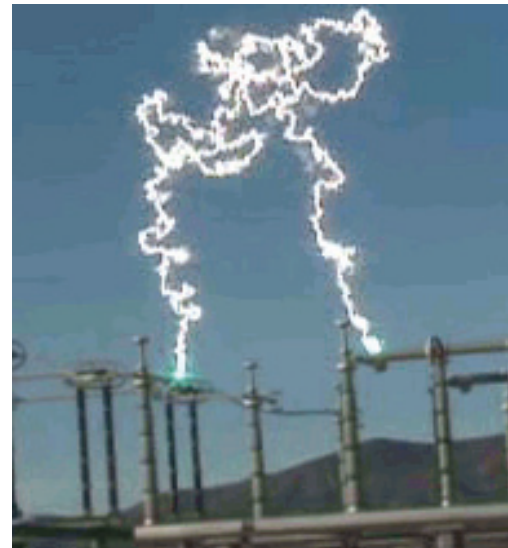
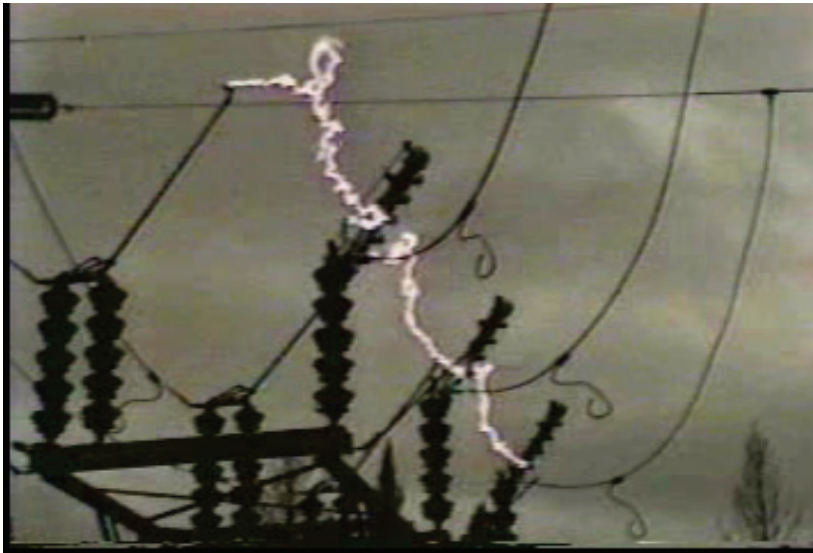

⇒ How to avoid the electrode influence and reduce the computation cost ?

« tip tip » configuration of 50 cm (1 million cells) ⇒ 8h/ms/proc

3,2 m arc during 300ms !!!

Tanaka et al., "Three Dimensional behaviour analysis of D.C. free arc column by image processing technique", GD 2000, Glasgow

II. Lightning Channel : modelling



Periodic arc column distribution (50cm, 250A, 23ms)

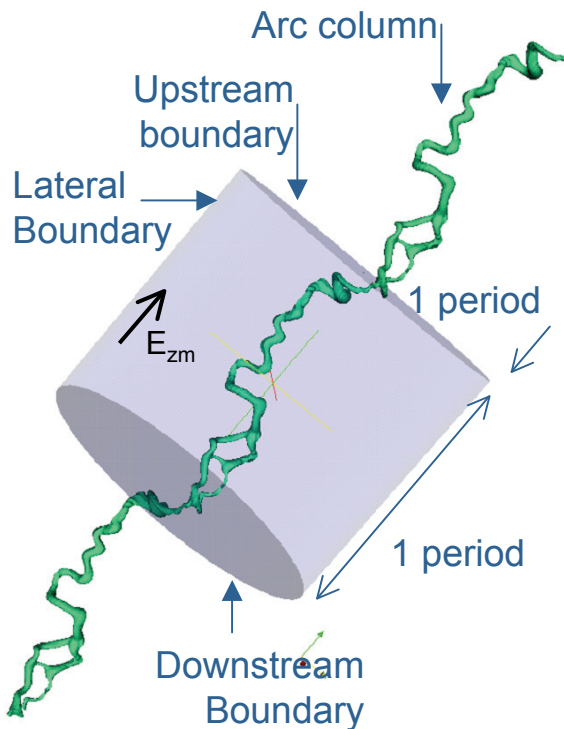

Formulation with “fluctuating potential” $\tilde{\varphi}$

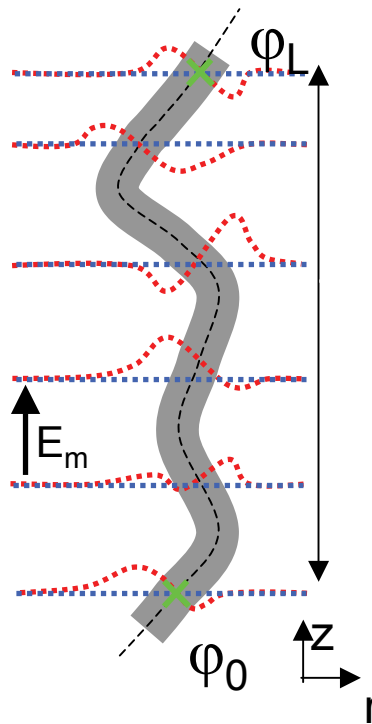

Current production: $\varphi_L > \varphi_0$
 Periodic distribution: $\varphi_L = \varphi_0$ } ???



Quasi uniform electric field,
 Quasi linear electric potential:

$$\varphi = \Phi + \tilde{\varphi} \quad \text{with} \quad \Phi = E_m z$$

$$\vec{E} = \vec{\nabla} \tilde{\varphi} + E_m \vec{u}_z$$



The current conservation equation writes:

$$\vec{\nabla} \cdot \sigma \vec{\nabla} \tilde{\varphi} = -E_m \partial_z \sigma$$

II. Lightning Channel : results



Evolution of the isotherm surfaces

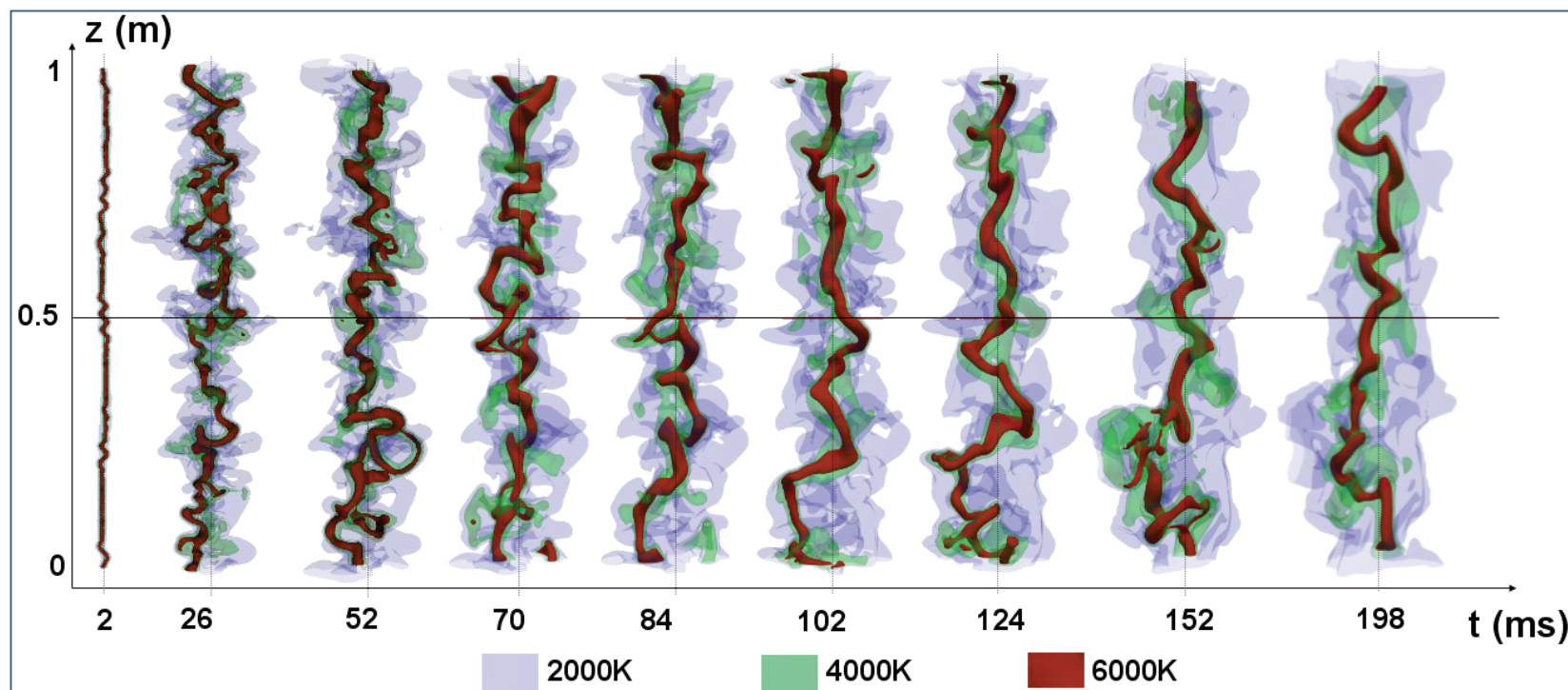

Latham, 1986 : 7000K with current of 100A

II. Lightning Channel : results



Evolution of the displacement velocity (m/s)

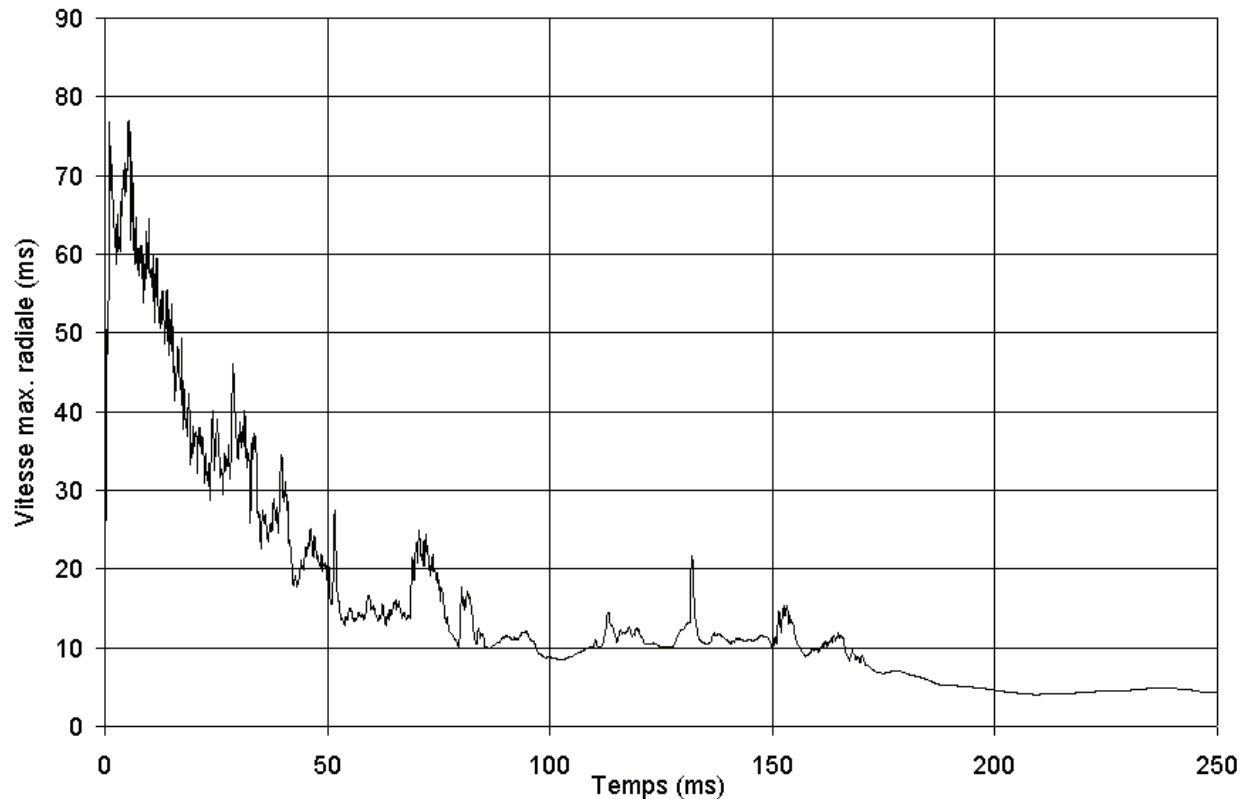

Sunabe and Inaba, 1989 : 10 m/s with 100A

Sunabe K, Inaba T, "Electric and Moving Characteristics of DC kilo-Ampere High Current Arcs in Atmospheric Air", IEEJ, vol.109-A, No.3, pp.95-102, 1989.

II. Lightning Channel : results



⇒ **RESULTS** : data for macroscopic lightning ONERA model

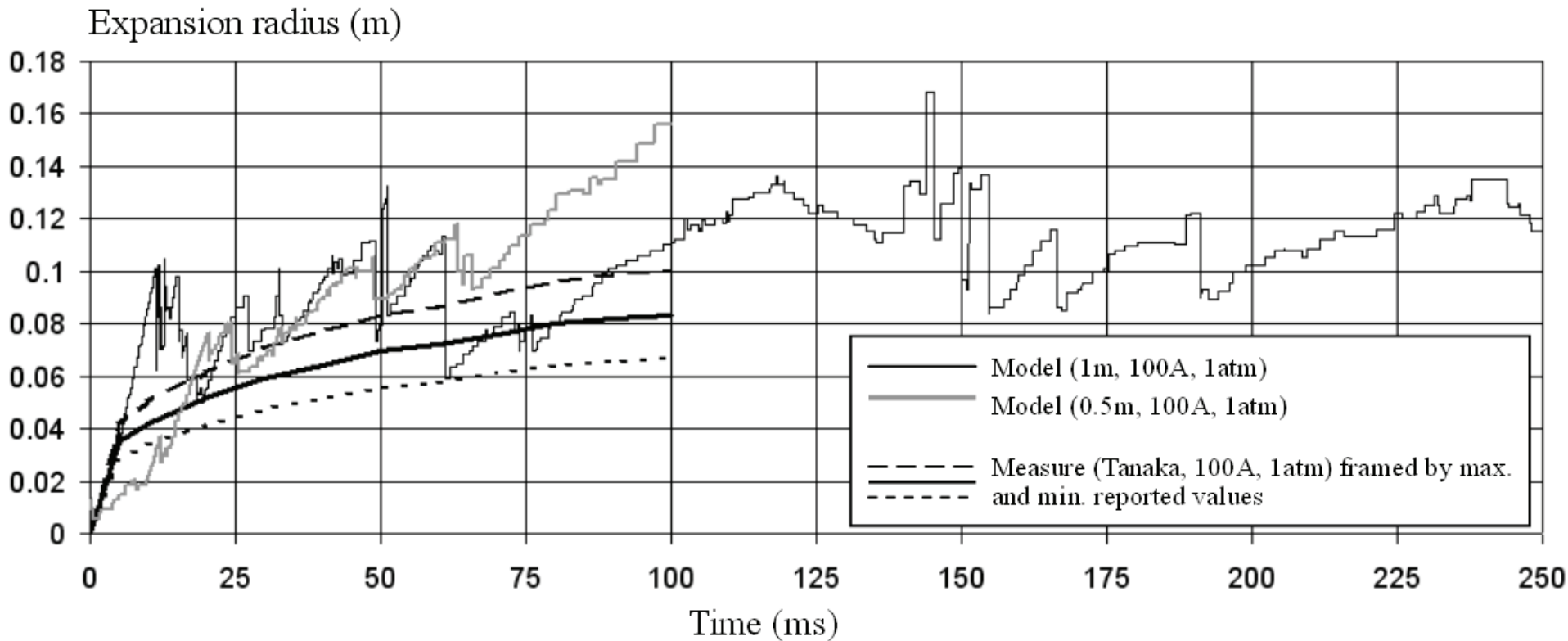

II. Lightning Channel : results



⇒ **RESULTS** : data for macroscopic lightning ONERA model

Normalized length

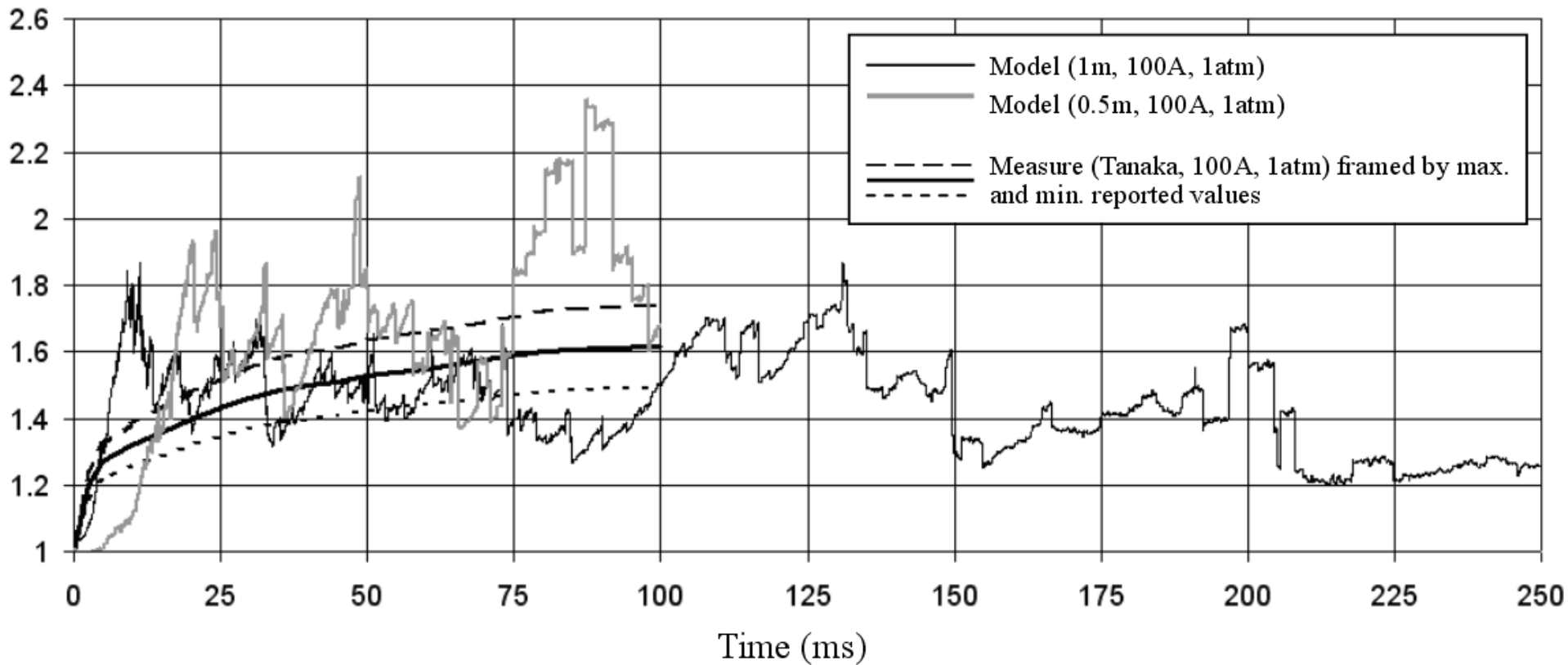

II. Lightning Channel : results



⇒ **RESULTS** : data for macroscopic lightning ONERA model

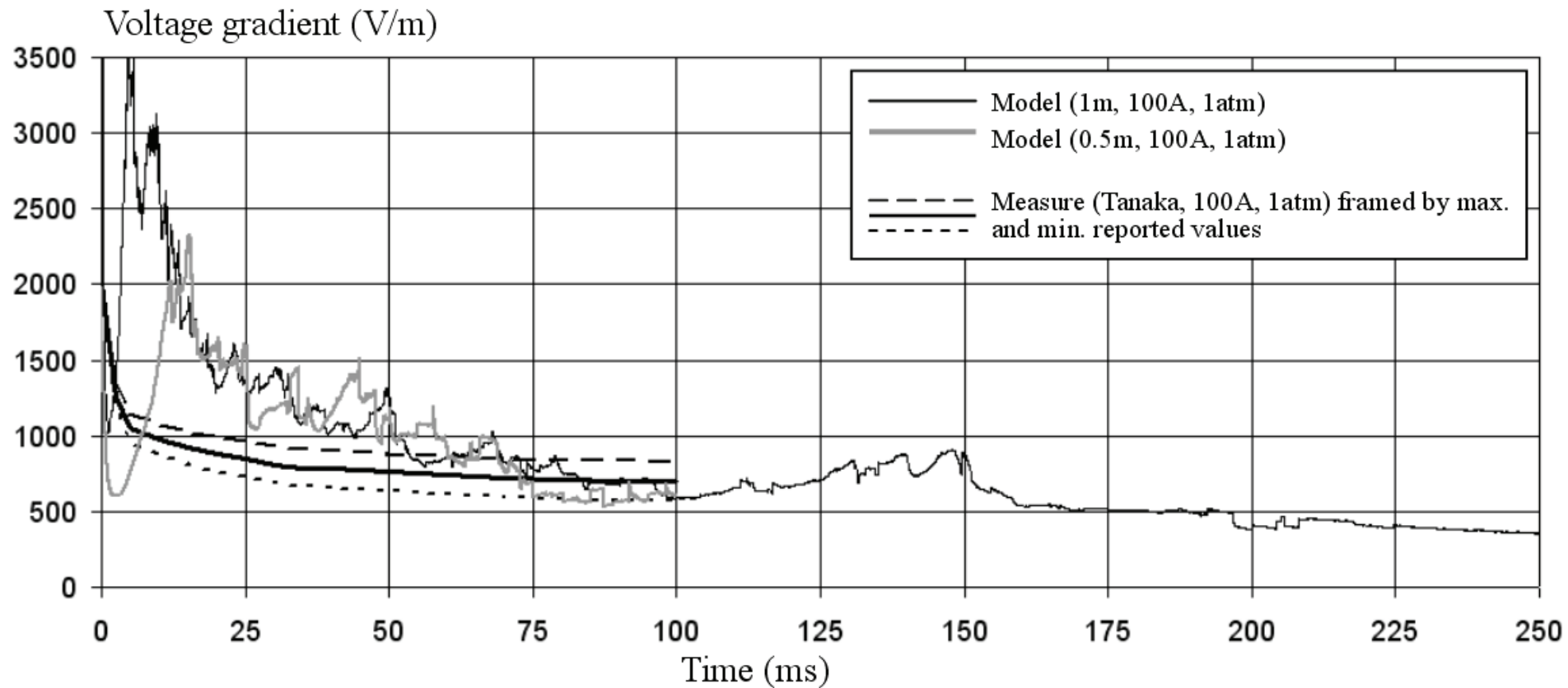

III. Lightning interaction with material : direct effects



Direct effects: damage at the attachment point

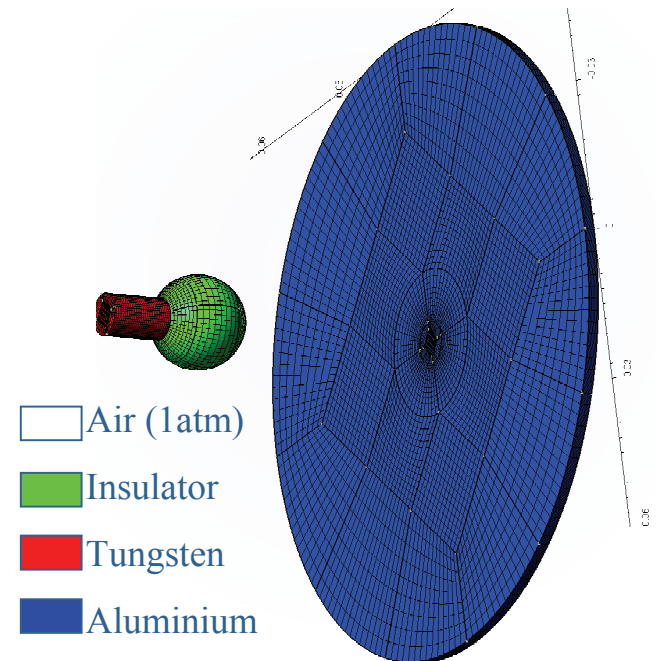
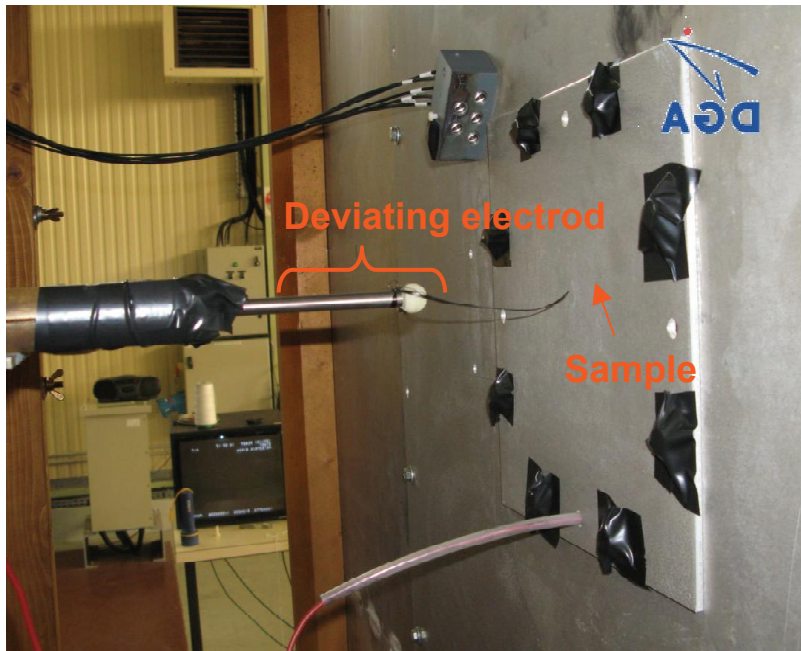

III. Lightning interaction with material : modelling



Simulation of electric arc including the electrodes

-Hydrodynamics in the electrodes !

« penalty method »

$$T_S = \frac{\rho}{\tau} (u - u_0) \quad \text{with} \quad \tau \ll \Delta t$$

- Electric conductivity σ discontinuity:

« Harmonic mean »

$$\sigma_{Interface} = 2 \frac{\sigma_{Fluid} \sigma_{Solid}}{\sigma_{Fluid} + \sigma_{Solid}}$$

- Vaporization of the electrode

Metallic massic fraction X at the interface

« penalty method »

$$T_S = \frac{\rho}{\tau} (X - X_{Model}) \quad \text{with} \quad \tau \ll \Delta t$$

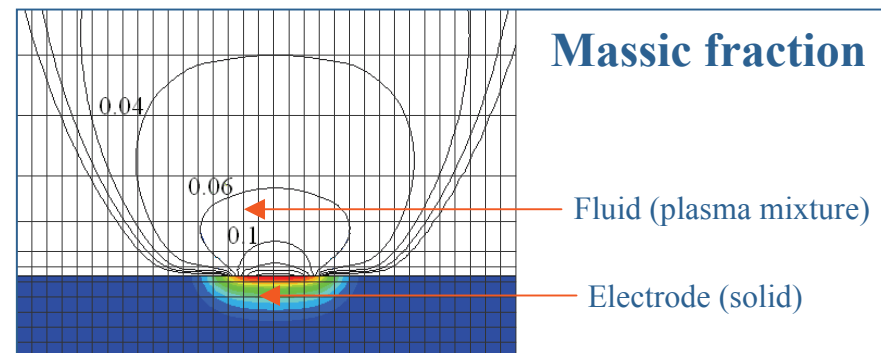
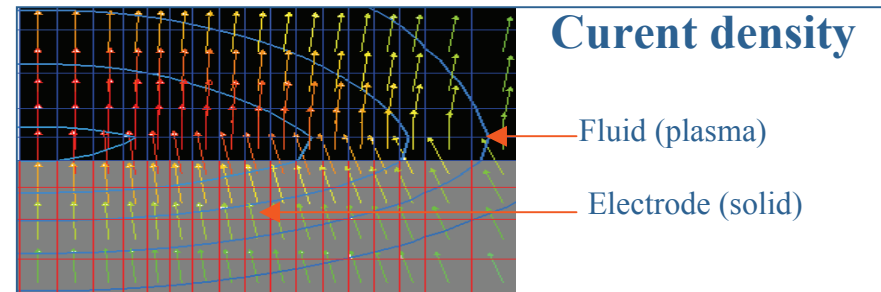
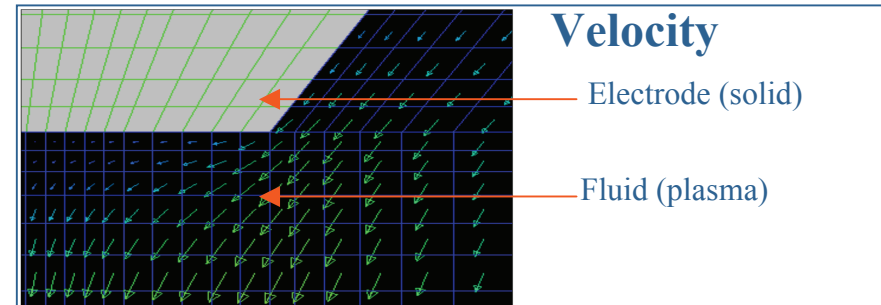

III. Lightning interaction with material : validation



Comparison with measurement: steady state argon arc (1cm, 200A)

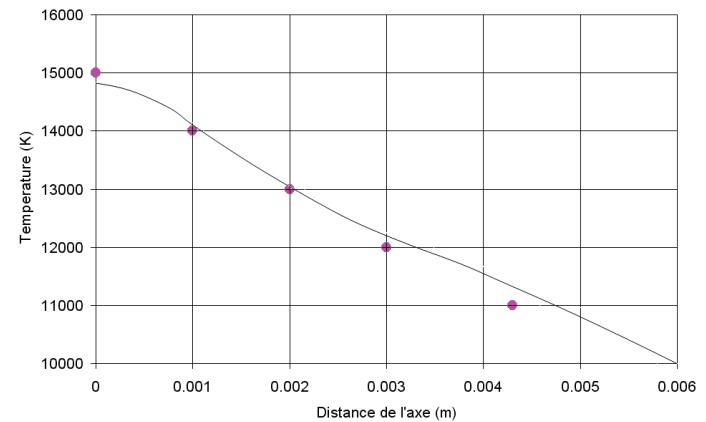
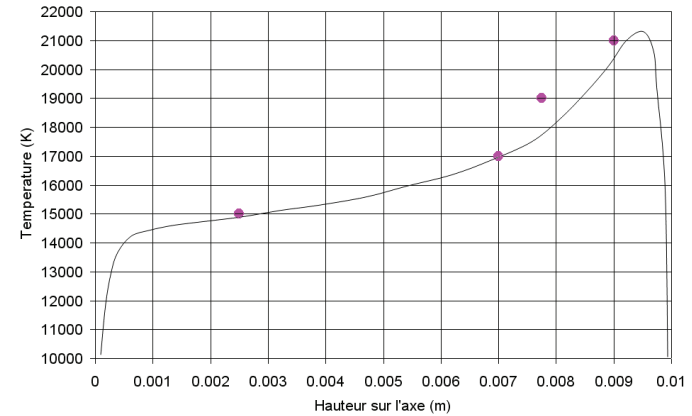
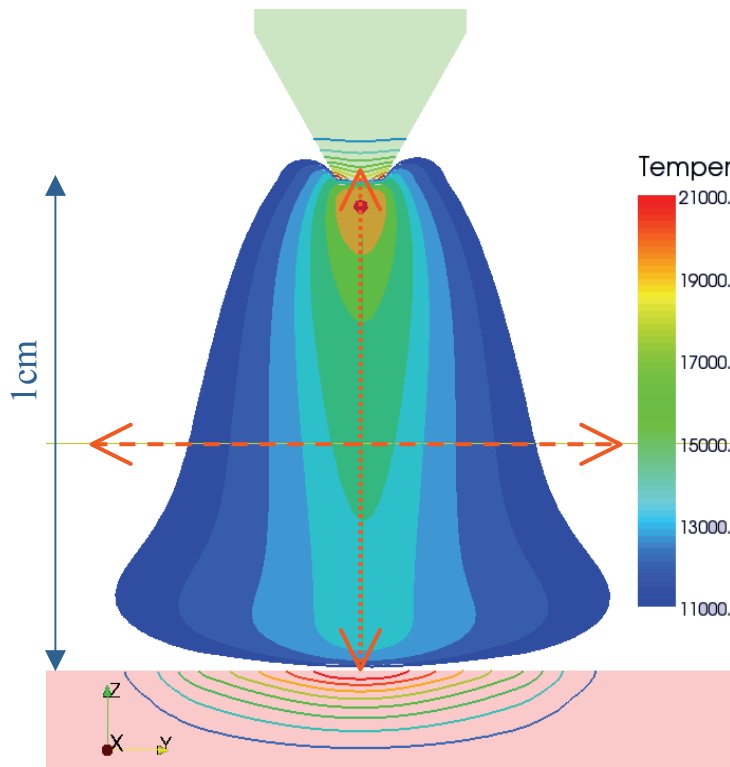

Hsu K.C., Etemadi K., Pfender E., "Study of the free-burning high intensity argon arc", J. Appl. Phys. Vol. 54 n3 (p 1293), (1983).

III. Lightning interaction with material : results



Comparison of the behavior

SIMULATION

Code_Saturne®
(24 ms, 5cm)

EXPERIMENT

CEAT
(24 ms, 5cm)

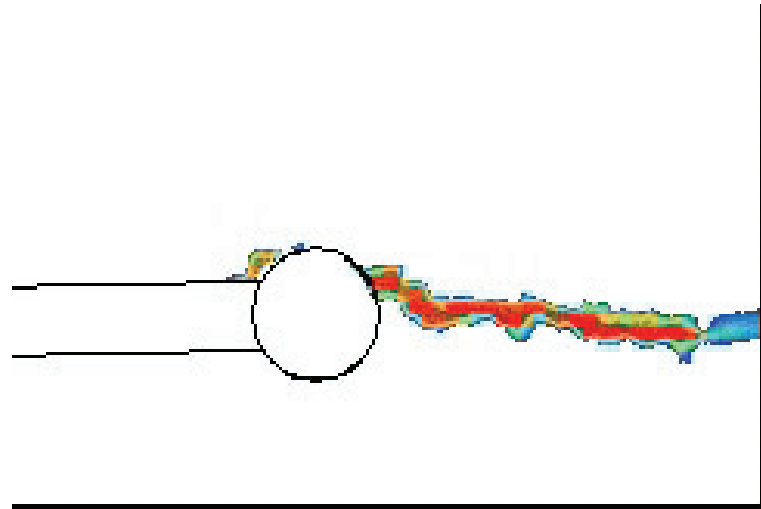
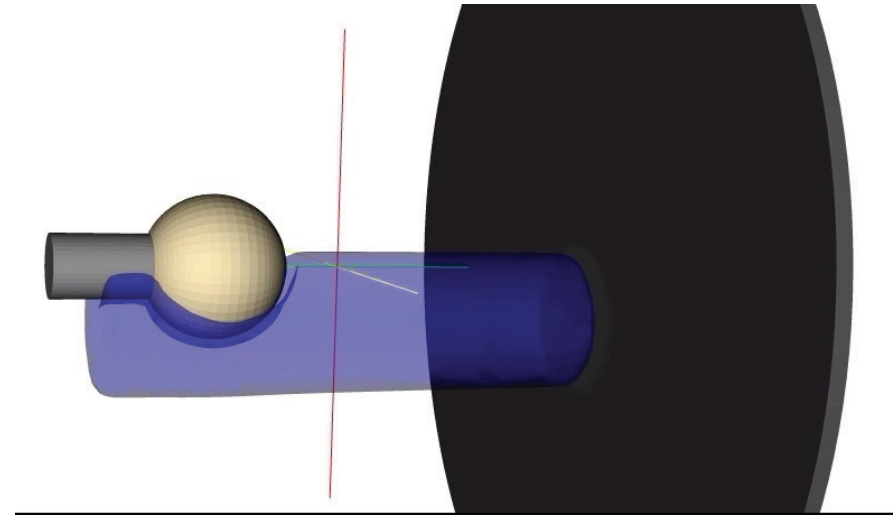

III. Lightning interaction with material : modelling



Moving arc root

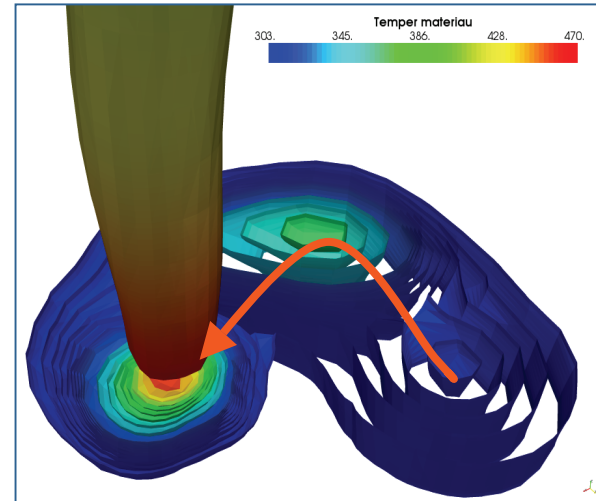
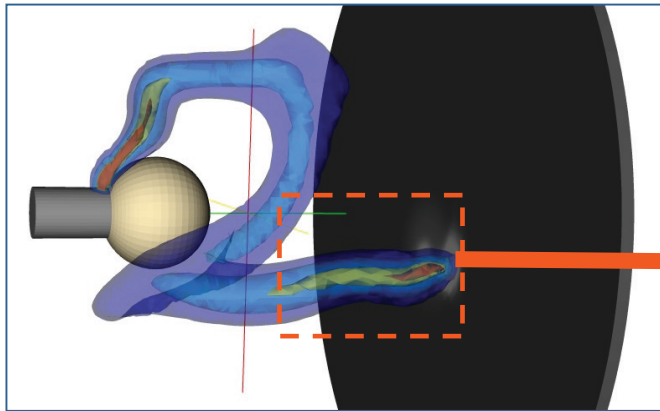

Steady state modeling of the arc root

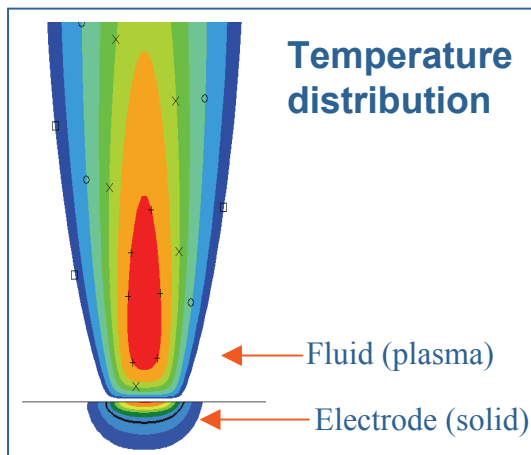

III. Lightning interaction with material : results



Steady state modeling of the arc root

Electrode vaporization time (ms) as a function of the current (A)

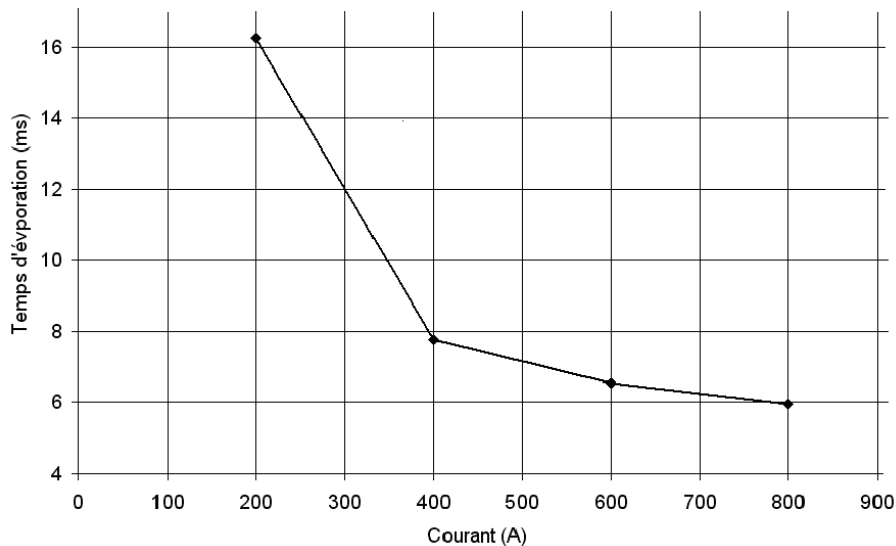

Evolution of the temperature (K) in a cathode (blue) and in an anode (pink) as a function of the time (μ s)

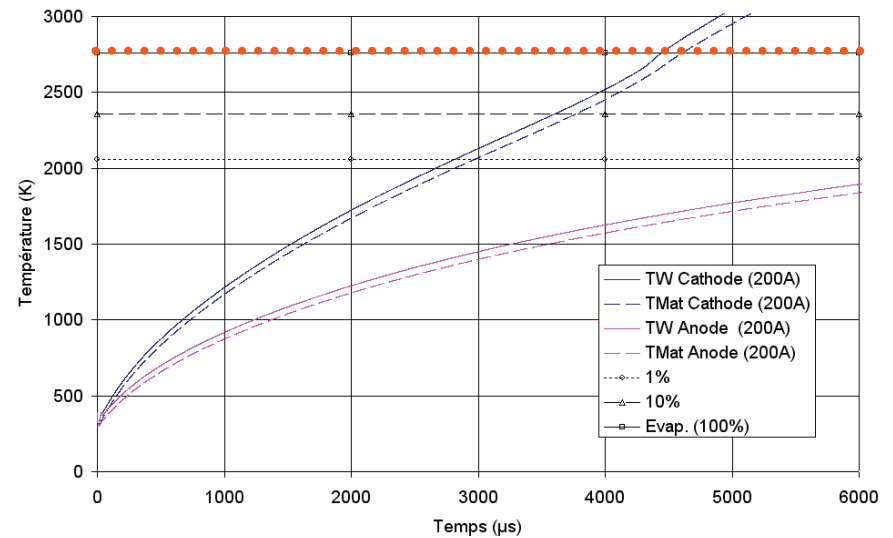

Conclusion

Lightning channel modelling

- With a periodic distribution (fluctuating potential)
- Good agreement with literature
- Used for macroscopic modelling of lightning



Lightning interaction modelling

- 1 computation domain including both solid (electrodes) and fluid
- Good agreement with the behavior on an unsteady case (experiment/simulation)
- Results for steady state arc :
 - Vaporisation of an anodic sample: 16ms with 200A, 5ms with 800A
 - Vaporisation of a cathodic sample: 4,5ms with 200A





Thank you for your attention